

Airflex® Clutches & Brakes

A complete line of quality clutches and brakes for industry

Catalog 900



EATON

Powering Business Worldwide

History and Development



Early interest by Thomas L. Fawick in the use of elastomers to solve industrial problems led to the development of the Fawick® Airflex clutch and the founding, in 1938, of the Fawick Company.

The Airflex clutch is a unique drum type design which transfers torque through the sidewalls of a rubber-and-cord air actuating tube. Besides transmitting torque, the tube serves as a flexible member between the driving and driven shafts. Simplicity in design and operation are its other outstanding features.

During the early 1940's, after many applications on tugs and tow boats, the U.S. Navy incorporated the clutch on reversing reduction drives for various types of military vessels. Thus the Airflex clutch was proven in severe Naval service.

During this same period, installations were made on oil field equipment and metal forming machinery. All of these successful applications generated worldwide interest and resulted in rapid company growth during the '50's and '60's.

In 1968, Eaton Corporation acquired the Fawick Corporation, as it was then known. Continuous refinements in design and construction of the original Fawick clutch resulted in the current line of Airflex clutches and brakes and the establishment of the Airflex Division of Eaton Corporation.

As a pioneer in the design, development and use of pneumatic clutches and brakes, the Airflex Division is proud that its products are so extensively used on all types of industrial machinery - from equipment to locate and mine raw materials to machines to produce consumer goods.

For over 75 years, the Airflex Division has been dedicated to solving mechanical power transmission problems. We will continue to do so.

Table of Contents

General Information	
Section A	4
Constricting Type Clutches and Brakes	
Section B	16
Expanding Type Clutches and Brakes	
Section C	116
Water-Cooled Brakes	
Section D	160
Air Cooled Disc Clutches and Brakes	
Section E	182
Clutch/Brake Packages	
Section F	204
Spring Applied Brakes	
Section G	231
Caliper Disc Brakes	
Section H	247
Rotorseals and Quick Release Valves	
Section I	260
Controls and Air Tank Groups	
Section J	279
Repair and Service Kits	
Section K	289
Product Application by Industry	
Section X	298
Technical Information	
Section Y	330
General Engineering Data	
Section Z	331

Airflex® Application Guide

Section A

In addition to the major products listed, Airflex rotorseals and quick release valves are used throughout these industries.

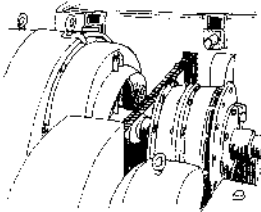
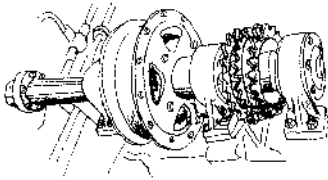
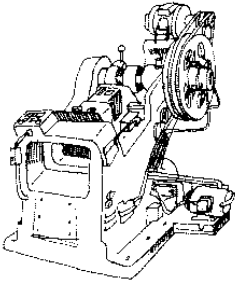

INDUSTRY	MACHINE OR EQUIPMENT	AIRFLEX PRODUCTS
Agricultural	Grain Elevator	E
	Irrigation	CB
	Sugar Refining	CB, EB, VC
Amusement	All types of amusement ride drives.	CB, VC CS, CTE, DBA
Breweries	Bottle Washers	CB, CS
	Conveyors	CB, CS
	Labeling	CB, CS
	Uncasers	CB, CS
Can Making	Bodymaker	CB, CS, CTE, DBA, DCB, FSPA, VC
	Cap Machine	FSPA
	Copper	CB, CS, CTE, DBA, DCB, FSPA, VC
	End Press	CB, CS, CTE, DBA, DCB, FSPA
	Necker-Flanger	DP
	Seamer	CB, CS
	Shell Press	CB, CS, CTE
	Strip Feed Press	CB, CS, CTE, DBA, FSPA, VC
	Tab Press	CB, CS
Ceramics & Clay	Block Splitter	CB, CS
	Brick Press	CB, CTE, DBA, VC
	Brick Stacker	DBA
	Extruder	CB, VC
	Kiln	CB, VC
	Oven	CB, VC
	Pug Mill	CB, VC
Chemical	Centrifuge	EB
	Compressors	CB, VC
	Hammer Mill	CB, VC
	Kilns	CB, DP, VC
	Mixers	CB, VC
	Pumps	CB,
Construction	Air Compressor	CB
	Blast Hole Drilling	CS, E
	Capstans	CB, E, VC, VE
	Conveyors	CB, DBA, DP, H, VC
	Engines (Power Take-Off)	CB
	Excavating	CB, DBA, VC
	Hoists	CB, CS, CTE, DBA, DP, H, VC
	Hydraulic Pump Drive	CB
	Insulation Shear	CB, CS, CTE, DBA, VC
	Locomotive Crane	CB, CS, CTE, DBA, DP, E, H, VC, VE
	Overhead Crane	CB, CS, CTE, DBA, DP, E, H, VC, VE
	Power Line Stringing	E, VC, WC
	Pumps	CB, VC
	Tunnel Boring	VC
	Winches	AS, CB, CS, CTE, DP, E, H, VC, VE, WC
Dynamometer	Absorber	DP, WC
	Holding Brake	CB, VC
Engines	Generator Set	CB, VC
	Power Take-Off	CB, VC

Airflex® Application Guide

Section A

INDUSTRY	MACHINE OR EQUIPMENT	AIRFLEX PRODUCTS
Fishing	Hoists & Winches Propulsion	E, VE, WC CB, CM, VC
Glass	Edging Decks Fiberglass Winders Glass Sand Mill Molding Shears	CB DP VC CB FSPA
Laundry	Bar Soap Extruders Extractors Washers	CB, CS CB, ER, VC CB, ER
Leather	Blade Grinder Die Cutting Embossers	CB CB, CS, CTE, CBC and AMCB Lutex, FSPA, VC FSPA
Logging	Skidders Yarders	DP E, VE, WC
Lumber	Band Saw Breakdown Hoist Carriage Drives Conveyors Plywood Stacking Setworks Stackers Veneer Clipping Veneer Lathe	DP CB, CS, CTE, CBC and AMCB Lutex, VC WC CB, VC CB, CS EB CB, CS, CBC and AMCB Lutex FSPA CB
Marine	Anchor Winch & Windlass Bow Thruster Deck Machinery Dredges Generator Main Propulsion Pipe Laying Equipment Power Take-off Propeller Shaft Brake Pumps Radar & Aerial Systems	WC CH, VC CB, DBA, E, VC, VE, WC CB, CH, E, VC, WC CB, VC CB, CM, VC VC, WC CB, VC DP, VC CB, VC CB, CSA
Material Handling	Bucket Elevator Conveyors Cranes & Hoists	CS CB, CTE, DBA, DP, VC AS, CB, CTE, DP, VC
Metalworking	Alligator Shear Car Shredders Coining Press Drawbenches Expanders Flywheel Brakes Forging Presses Headers & Upsetters	CB, CS, DBA, FSPA, VC CB, CM CB, CS, CTE, FSPA VC CB, CTE, FSPA, VC DP, H CB, CS, CTE, DBA, DCB, CBC and AMCB Lutex, FSPA, VC CB, CS, CTE, DBA, DCB,

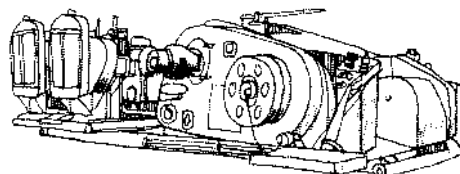
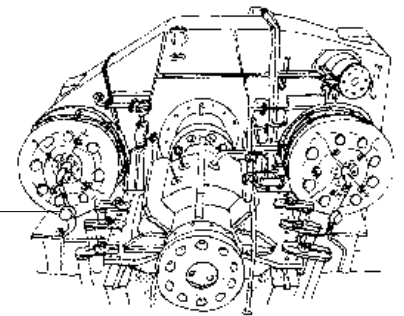
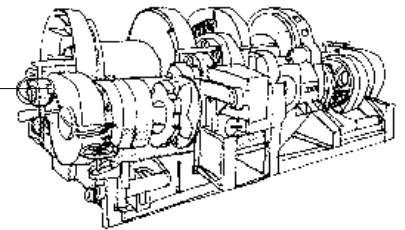
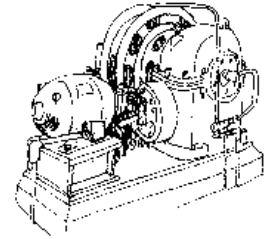

Airflex® Application Guide

Section A

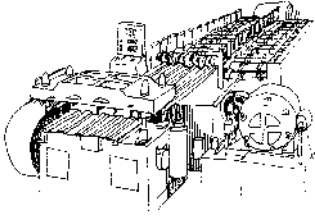

INDUSTRY	MACHINE OR EQUIPMENT	AIRFLEX PRODUCTS
Metalworking (continued)	Machine Tools	CBC and AMCB, FSPA, VC
	Multi-Slide	AR, AS, CB, VC
	Powder Metal Presses	CB, CS
	Press Brakes	CBC and AMCB, FSPA
		CB, CS, CTE, DBA, DCB,
		CBC and AMCB, FSPA, VC
	Rebar Shear	CB, CS, CTE, FSPA
	Rewind Stands	E, PCB
	Roll Forming	CB, VC
	Roller Leveler	CB, CS
	Shears	B, CS, CTE, DBA, DCB,
		CBC and AMCB, FSPA, VC
	Slitters	CB, VC
	Spring Coiling	FSPA
	Stamping, Punching & Forming Presses	CB, CS, CTE, DBA, DCB,
	CBC and AMCB, FSPA, VC	
Unwind Stands	DP, E, EB, H, WC	
Wire Cage	CB	
Mining & Cement	Blast Hole Drill	CS, E
	Conveyors	CB, DBA, VC
	Crushers	CB, VC
	Dragline	CB, DBA, VC, FHB
	Vertical Roller Mill	VC
	Drilling	CS, E
	Elevators	CB, CTE
	Grinding Mills	VC
	Hammer Mills	VC
	Kilns	CB, VC
	Locomotives	DP, WC
	Pulverizers	CB, VC
	Shovels	DBA
	Shuttle Cars	AR, AS, DP
	Ventilating Fan	VC
Miscellaneous	Clamping Device	CB
	Lifting Device	CB, EB, ER
Paper	Calendar	CB, VC
	Chippers	DP, H
	Converters	DP, WC
	Conveyors	CB, DP, H, VC
	Core Expanders	EB
	Couch	CB, ER, PCB, VC
	Debarkers	CB, VC
	Dryer	CB, VC
	Presses	CB, PCB, VC
	Pulpers	CB, VC
	Reel	CB, PCB
	Rewind Stand	E
	Slitters	CB
	Unwind Stand	DP, E, H, WC
	Woodyard Machinery	CB, CS, DBA, VC
Yankee Dryer	CB, VC	
Printing	Book Binder	CB
	Paper Shear	CB, CS, VC
	Presses	CB, CS, DP, SC
Rubber	Calendars	CB, CS, CTE, VC
	Clipper Press	FSPA
	Mills	CB, CS, CTE, VC
	Mixer	CB, VC
	Tire Builders	CB, EB

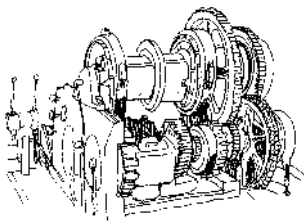
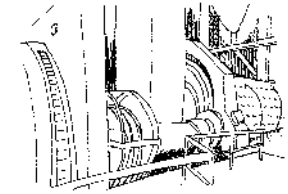

Airflex® Application Guide

Section A

INDUSTRY	MACHINE OR EQUIPMENT	AIRFLEX PRODUCTS
Steel	Accumulator	CB, E
	Conveyors	CB, VC
	Heat Treating Furnace	CB
	Rewind Stands	CB, E
	Rolling Mills	CB, VC
	Rollover	VC
	Sand Mullers	CB, VC
	Screwdowns	CB, VC
	Tube Mills	CB, VC
	Unwind Stands	DP, E, H, WC
	Wire Drawing	DP
Textile	Beaming Machines	CB, E, EB, VC
	Rag Cleaning Mill	CB
	Rag Cutting	CB
	Warping Machines	CB, E, EB, VC
Turbines	Starter Drive	CB
	Water	DP, H, VC
	Windmill	DP, H, VC
Test Benches & Stands	Car/Truck Dynamometer	VC, WC
	Dynamometer	CB, WC, WCSB
	Engines	CB
	Gear Boxes	WC
Transportation	Airport Ramp	CB
	Locomotive Compressor	CB
	Locomotive Fan	CB
	Plane Ground Support	CB
Gas, Oil, Water Well Drilling	Cat Head	CB, VC
	Compound	CB
	Construction Barge	WC
	Drawworks	CB, VC
	Inertia Brake	CB, DP, VC
	Offshore Pipe Laying	WC
	Power Take-Off	CB
	Pumps	CB
	Rotary Table	CB, DP, E, VC
	Sand Reel	CB, VC
	Semi-Submersible Anchor	
	Mooring Systems	VC, WC

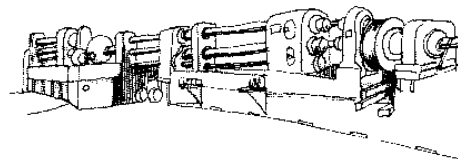
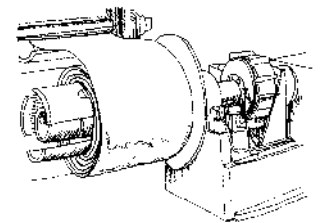
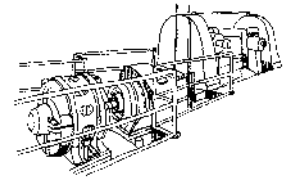
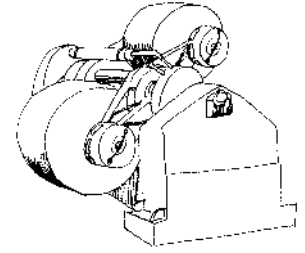

Constructing Type Clutches and Brakes

Section B

Type CB

Torque capacities up to:

1,160,000 lb•in

131.000 N•m

Airflex CB element assemblies are used as both clutches and brakes in general power transmission service. The primary feature of the CB design and construction is the Airflex torsional resilient principle made possible by the transmission of power through the side walls of the flexible neoprene and cord actuating tube. This flexibility also permits minor shaft misalignment.



Type VC

Torque capacities up to:

13,877,000 lb•in

1567.000 N•m

Airflex VC element assemblies are designed and built for severe clutching and braking applications on heavy duty equipment. They are unmatched for high starting loads and sustained slippage where heat generated tends to lower efficiency and shorten the operating life of conventional clutches. Their high torque ratings permit use of smaller diameter units which lowers contact velocity on high speed applications. Ventilated construction permits passage of cooling air, to rapidly dissipate heat from the friction shoes. Torque is transmitted from the side plates of the elements through torque bars to the friction shoes.



Type CM

Torque capacities up to:

3,236,000 lb•in

365.000 N•m

Airflex CM element assemblies were designed primarily for the marine industry for use on diesel driven reverse-reduction gears. In addition to providing all of the CB element features, their ventilated friction shoes permit clutch slippage at low energy rates during vessel maneuvering, as well as cycling engagements at high energy rates. Rim registering allows triple element assemblies.



Constructing Type Clutches and Brakes

Section C

Type E

Torque capacities up to:

1,010,000 lb•in

114.000 N•m

Airflex E elements are primarily used as slip clutches or tension brakes; however, they can also be used for general power transmission service. Torque is transmitted from the friction shoes to the element housing through torque bars. Engagement occurs when air expands the actuating tube forcing the friction shoes against the inside diameter of the drum. Release springs assist shoe disengagement and counteract centrifugal force.



Type VE

Torque capacities up to:

221,000 lb•in

24.950 N•m

Airflex VE elements were specially designed for greater heat dissipation capacity in an expanding type element. Available in a limited number of sizes, they offer all of the type E features.



Type EB

Torque capacities up to:

98,580 lb•in

11.130 N•m

Airflex EB element assemblies are used in both clutch and brake service with light starting loads. The EB is similar in design to the CB except that it is an expanding type unit.



Type ER

Torque capacities up to:

118,000 lb•in

13.300 N•m

Airflex ER couplings are expanding units with neoprene facing. As such, they combine the advantages of a flexible and disconnect coupling. Engagement of the element should occur when there is no speed differential between driving and driven shaft.

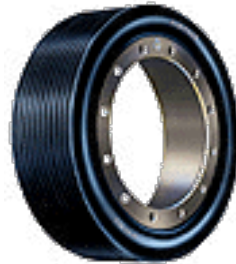

Water-Cooled Brakes

Section D

Type WCB2/ WCBD

Torque capacities up to:

2,700,000 lb•in

304.830 N•m

Thermal capacities up to:

5,200 HP

3,878 kW

Airflex WC air applied and spring applied water cooled brakes are designed for applications requiring high horsepower absorption. Its design incorporates copper alloy wear plates which transfer heat rapidly to circulating water. They are used for heavy-duty braking and tensioning applications, such as those found in metal and paper processing, as well as for cable tension control on logging, marine mooring and winching equipment. The unit can also be used as an absorption dynamometer.



Type WCSB

Type WCSB

Torque capacities up to:

5,548,000 lb•in

636,369 N•m

Thermal capacities up to:

3900 HP

2908 kW

Airflex WCSB is an air applied, water and air cooled multiple disc brake/tensioner designed for heavy-duty brake/tensioning applications. It is similar to the WCB line except for a feature that allows for greater control of the braking/tensioning function.



Air Cooled Disc Clutches and Brakes

Section E

Type DBA

Static torque capacities up to:

386,630 lb•in

43.050 N•m

Airflex DBA disc style brakes are spring-applied and air or hydraulically released. Its torque capacities and heat dissipation characteristics make it ideal for high speed cyclic applications. Equal torque is developed in either direction of rotation.



Type DBB

Static torque capacities up to:

2,535,750 lb•in

286.524 N•m

Airflex DBB disc style brakes are spring-applied and air or hydraulically released. Its torque capacities and heat dissipation characteristics make it ideal for high speed cyclic applications. Equal torque is developed in either direction of rotation.



Type DBBS

Static torque capacities up to:

5,578,000 lb•in

630.282 N•m

Airflex DBBS disc style brakes are spring-applied and air or hydraulically released. Its torque capacities and heat dissipation characteristics make it ideal for high speed cyclic applications. Equal torque is developed in either direction of rotation.



Type DC

Torque capacities up to:

2,061,000 lb•in

233.000 N•m

Airflex DC clutches and brakes are available in single and multiple disc designs. They feature a favorable torque to size ratio and low inertia friction disc assemblies.



Type FHB

Torque capacities up to:

432,900 lb•in

48,918 N•m

Spring-applied, pressure released, disc style brakes develop equal torque in either direction of rotation. The revolutionary floating housing concept helps provide quick change friction capability with longer friction life than traditional caliper brakes.



Clutch/Brake Packages

Section F

Press Application Clutch/Brake and Control

Clutch capacities to:

516,000 lb•in

58.260 N•m

Brake capacities to:

336,200 lb•in

37.960 N•m

Airflex Press Application packages feature drum type CB or VC air applied clutches fastened to standard bearing-mounted flywheels. These clutch/flywheel assemblies are then combined with drum type CS and CTE or disc type DBA spring-applied, air released brakes. Although designed primarily for punch press use, they have found application on all types of cyclic equipment.

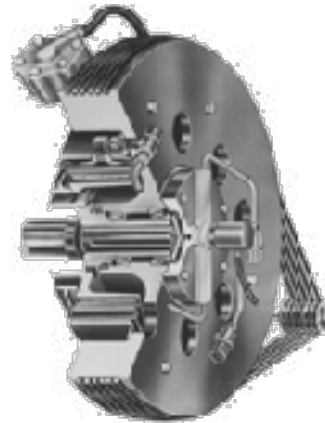

CBC

Clutch/Brake Combination

Clutch capacities to:

1,140,000 lb•in

128.799 N•m

Brake capacities to:

483,000 lb•in

54.570 N•m

The Airflex CBC unit combines an air actuated disc clutch and spring-applied brake into a compact package, which can be readily adapted to new or existing flywheel drives. Designed primarily for high cyclic punch press service, the unit has been applied on a wide variety of high speed, high cyclic applications.



Type DCB

Clutch capacity: Brake capacity:

75,000 lb•in

55,000 lb•in

8475 N•m

6215 N•m

Airflex DCB combination air-actuated disc clutches and spring-applied disc brakes were specifically designed for the can making industry. It is ideally suited for high speed continuously running machinery requiring an extremely fast stop.

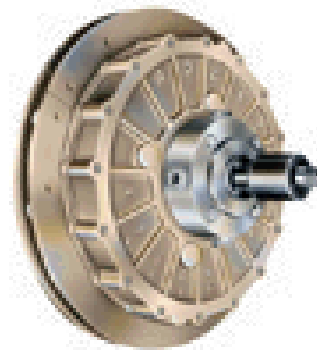

Type AMCB

Clutch capacity: Brake capacity:

142,800 lb•in

66,300 lb•in

16,140 N•m

7490 N•m

The Airflex® AMCB AccuStop™ is engineered for small-to-medium tonnage, high speed, high cycle punch presses, AMCB AccuStop™ unit delivers high torque and low inertia in a compact design.



Spring Applied Drum Brakes

Section G

Type CS

Static torque capacities up to:

19,800 lb•in

2.235 N•m

Airflex CS drum style brakes are spring-applied and air released. It automatically engages should an air or electrical loss of power occur. The brake is unidirectional, developing less torque in the reverse direction of drum rotation.



Type CTE

Static torque capacities up to:

108,350 lb•in

12.200 N•m

Airflex CTE drum style brakes are spring-applied, air released and develops greater torque than Type CS. Its design and construction are ideal for moderate speed, high torque, cyclic applications. The brake is bi-directional, developing approximately the same torque in either direction of drum rotation.



Caliper Disc Brakes

Section H

Type DP & H

Frictional force capacities up to:

5,300 lb•in

23.575 N•m

Airflex caliper design features opposed pistons for balanced braking. Their symmetrical split construction accommodates discs of any thickness and permits mounting from either side or at the split line.

Type DP is ideally suited for most stopping and light tensioning applications. An automatic adjustment mechanism compensates for lining wear and maintains constant release clearance and response time.

Model H is suited for stopping high inertia loads on large diameter discs. Its design automatically compensates for disc runout.



Type 200DPA

Frictional force capacities up to:

6,300 lb•in

28,023 N•m

The Eaton Airflex® Type 200DPA is a symmetrical opposed piston caliper brake design that is well suited for most high torque, high energy stopping applications.



Rotorseals and Quick Release Valves

Section I

Rotorseals

Airflex rotorseals allow passage of pressurized fluids from a stationary inlet to a rotating shaft end. Single, dual and triple passage rotorseals are available in a variety of sizes and designs to meet most flow requirements. The multiple passage units can be used for individual control of components mounted on the same shaft, component lubrication and circulating fluid systems.

Single Passage

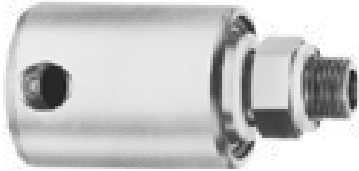

Dual Passage



Triple Passage

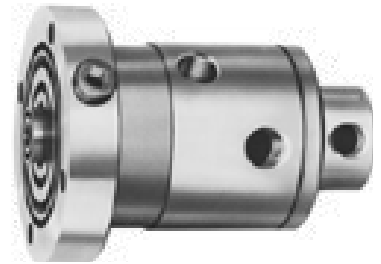

Quick Release Valve

Airflex Quick Release Valves provide rapid evacuation of pressurized air from pneumatic devices. They provide an exhaust port at the device rather than at the end of a long supply line and/or control component. Exhaust is rapid and positive as soon as there is a pressure drop in the supply line. Mufflers are available to reduce exhaust noise.

